

# **KitchenAid<sup>®</sup>**

*Large Capacity Clothes Dryer*

**Model KEYL400W Electric**  
**Model KGYL400W Gas**

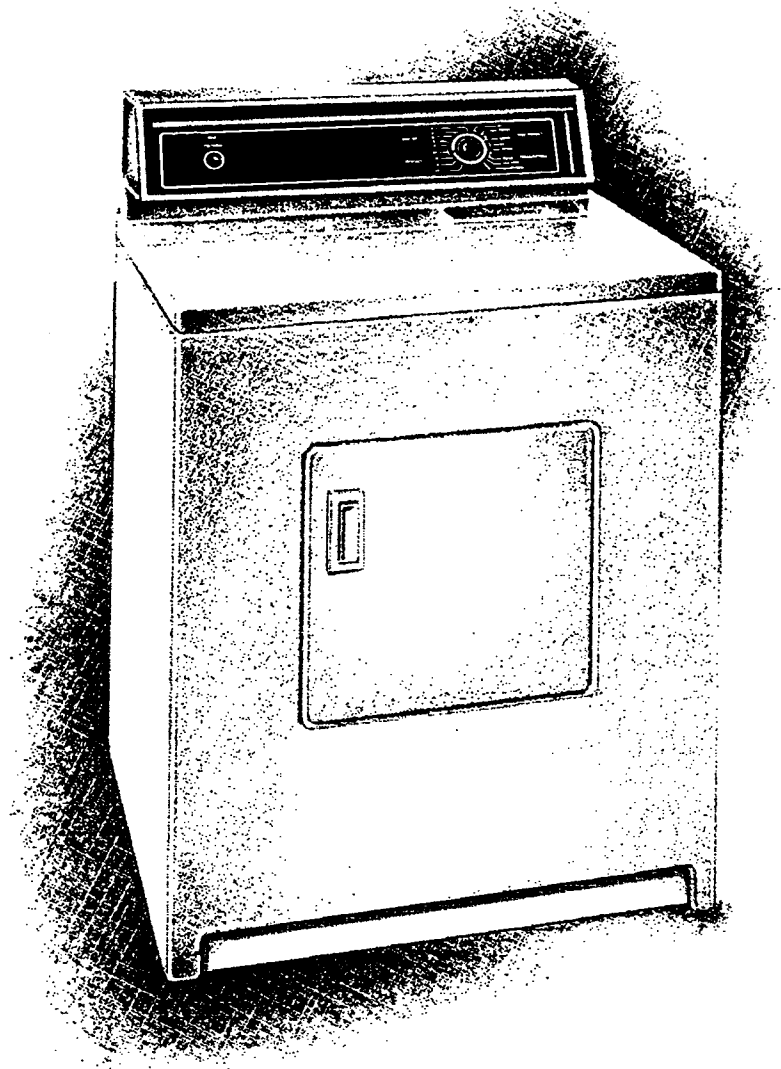

**USE and CARE GUIDE**

# Table of Contents

Important Safety Instructions .....	3
You Are Responsible For .....	4
Ownership Registration .....	4
Clothes Dryer Features .....	5
Operating the Clothes Dryer .....	6
Energy Saving Tips .....	6
Load Preparation .....	7
Loading .....	7
Load Sizes .....	7
Fabric Softener .....	7
Make Selections .....	8
Select a Cycle .....	8
Start the Dryer .....	8
To Stop and Restart the Dryer .....	8
End of Cycle Signal .....	8
Automatic Drying Cycles .....	8
Automatic Regular/Heavy Cycle .....	9
Automatic Permanent Press Cycle .....	9
Air Tumble Cycle .....	10
Timed Dry Cycle .....	10
Lint Screen .....	11
Lint Screen Maintenance .....	11
Cycle Selection Chart .....	12
Caring for the Clothes Dryer .....	13
Lint Removal .....	13
Cleaning the Dryer .....	15
Vacation Care .....	15
Common Drying Problems and Causes .....	16
Drying Tips .....	17
Drying Special Items .....	18
For Service or Assistance .....	22
KitchenAid Dryer Warranty .....	BACK COVER

©1992 KitchenAid

# Important Safety Instructions

## **⚠ WARNING**

To reduce the risk of fire, electric shock, or injury to persons when using the dryer, follow basic precautions, including the following:

1. Read all instructions before using the dryer.
2. Your dryer should be installed in an area protected from weather.
3. Your dryer should be connected to the right kind of outlet, electrical supply and grounding. See the Installation Instructions for complete information.
4. Never dry articles in the dryer that have been spotted, cleaned, washed or soaked in gasoline, wax, paint, or other flammable fluids. The fumes can create a fire hazard or explosion. Always hand launder and air dry fabrics containing these materials.
5. Never use heat to dry articles containing foam rubber or similarly textured rubber-like materials.
6. Fire hazard and damage to some materials can result from:
  - operating the dryer with the lint screen loose, damaged or missing.
  - allowing lint to build up inside the dryer and exhaust system. The exhaust duct and interior of your dryer should be cleaned by a qualified technician at least once every two years. See page 13 for lint removal instructions.
7. Never allow children to play on or in the dryer. Close supervision is necessary when this or any appliance is used near children.
8. When discarding an old dryer, always remove the door to prevent accidental entrapment.
9. Do not tamper with controls.
10. Do not reach into the dryer if the drum is moving.
11. Do not let dust, lint, paper, rags, or chemicals pile up around or under the dryer. Do not install against draperies or curtains. Keep area around the exhaust opening free from accumulation of lint, dust and dirt.
12. Do not install or perform any servicing unless you are qualified. Improper installation, repair, or servicing may result in personal injury or fire hazard.
13. Do not use fabric softeners or products to eliminate static unless recommended by the manufacturer of the fabric softener or product.
14. Clean lint screen before each load.

## **SAVE THESE INSTRUCTIONS**

### **FOR YOUR SAFETY**

If you smell gas:

1. Open the windows.
2. Don't touch electrical switches.
3. Extinguish any open flame.
4. Immediately call your gas supplier.

### **FOR YOUR SAFETY**

Do not store or use gasoline or other flammable vapors or fluids, such as dry-cleaning solvents or kerosene, in or near your dryer or any other appliance. The fumes can create a fire hazard or explosion.

# You Are Responsible For

## YOU ARE RESPONSIBLE FOR MAKING SURE THAT YOUR DRYER:

- Is installed by a qualified installer.
- Is properly maintained.
- Is properly installed and leveled in a well-ventilated room on a floor that can support the weight.\*
- Is located in an area where the temperature is above 45°F (7°C).
- Is properly connected to fuel and exhaust systems.\*
- Is used only for its intended function.
- Is not run where there may be explosive fumes.
- Is not used by children or anyone unable to operate it properly.

ALWAYS unplug the power supply cord or turn off electrical power before attempting to service the dryer. Shut off the gas valve if yours is a gas dryer.

ALWAYS shut off the gas valve before leaving on vacation.

NEVER operate the dryer if:

- It is not working properly (i.e., too noisy, too hot).
- It is damaged.
- Parts are missing (i.e., door, latch).
- All panels are not in place.
- Lint screen is not in place.

\* See the Installation Instructions for complete information.

## Ownership Registration

Please fill out and mail your Ownership Registration Card packed with the product. The card will enable us to contact you in the unlikely event of a product safety notification and assist us in complying with the provisions of the Consumer Product Safety Act. Return of the card is not necessary to validate your warranty.

You must provide proof of purchase or installation date for in-warranty service.

For your own records, write down the following information in the space provided below. If your dryer ever requires service, the service technician may need this information.

**Model Number\*** \_\_\_\_\_

**Serial Number\*** \_\_\_\_\_

**Date Purchased** \_\_\_\_\_

**Date Installed** \_\_\_\_\_

**Dealer's Name** \_\_\_\_\_

**Address** \_\_\_\_\_

**Phone** \_\_\_\_\_

\*Model and serial numbers are located on a label in the lower left-hand corner of the door opening.

# *Clothes Dryer Features*

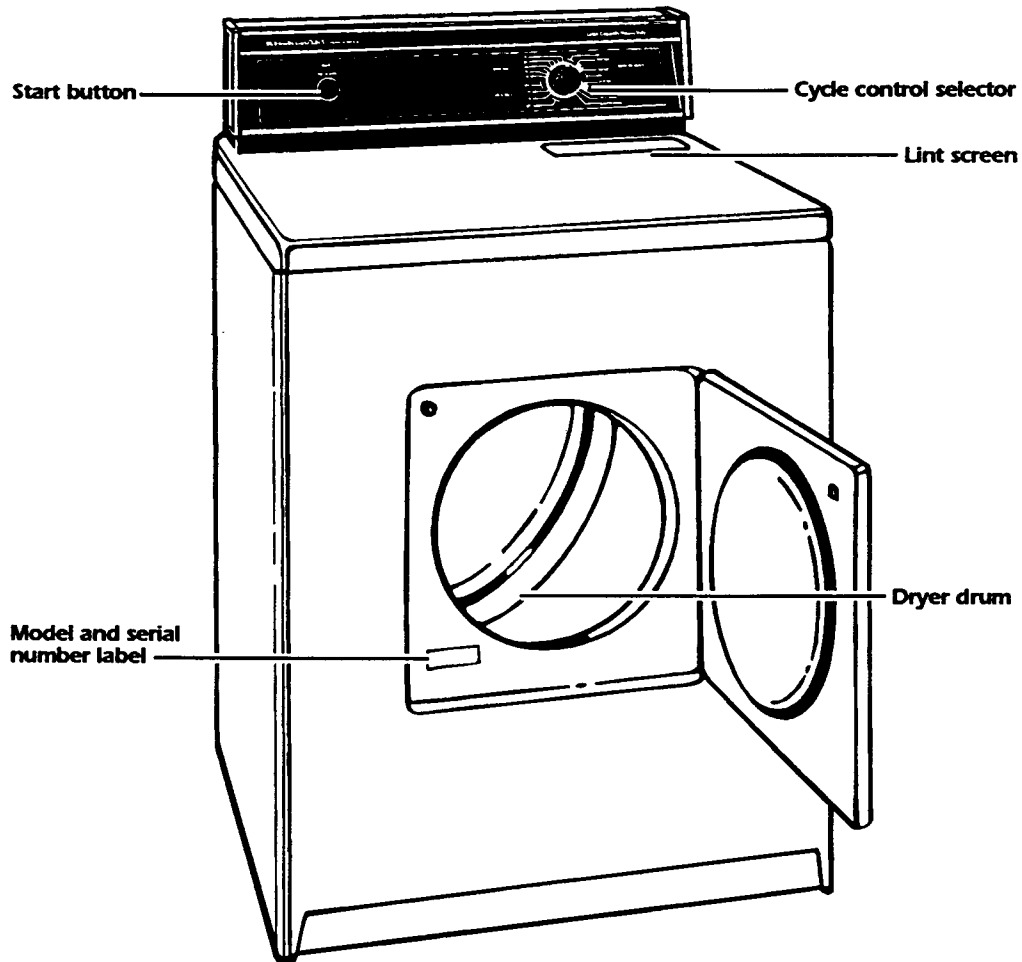

# *Operating the Clothes Dryer*

**Step 1** Add sorted load. See page 7 for information on load sizes and sorting.

**Step 2** Add fabric softener. See page 7 for information on fabric softener use.

**Step 3** Close the dryer door. The dryer will not operate if the door is open.

**Step 4** Select a cycle. See pages 8-10 for a description of cycle options.

**Step 5** Start the dryer. See page 8 for instructions on Cycle Control Selector use.

## *Energy Saving Tips*

**You can help save energy if you:**

1. Don't overload the dryer. Load must be able to tumble freely for fastest, most wrinkle-free drying.
2. Clean lint screen before each load. A build-up of lint on the screen can lengthen drying time.
3. Don't overdry. Use an automatic cycle to help prevent overdrying. Remove load when dryer stops.
4. Dry only full loads. Drying small loads wastes energy.
5. Separate light from heavyweight fabrics for faster, more even drying.
6. Wash and dry several loads consecutively. A warm dryer shortens drying time.
7. Don't add wet items to a partially dried load.
8. Don't open the dryer door unnecessarily. Warm air escapes from the dryer into the room.
9. Locate dryer in an area where room air temperature is above 45°F (7°C). Drying time is longer in unheated garages or utility rooms.
10. Make sure the dryer is exhausted properly to the outside. Keep exhaust duct clean and check flapper to make sure it opens and closes freely.

# Load Preparation

For best results, the following steps should be taken to prepare your clothes for drying.

- Separate heavy fabrics (denim and towels) from light fabrics (synthetics and permanent press).
- Separate lint givers (towels and chenille) from lint takers (corduroy, synthetics and permanent press). When possible, turn lint givers inside out.
- Separate dark from light colors, and colorfast from non-colorfast.
- Empty all pockets. A small scrap of paper can cause a lot of lint. Turn pockets of heavy items inside out for even drying.
- Some clothing has heat-sensitive trim which can be damaged by drying. Check garment's care label.
- Tie strings and sashes so they won't tangle.
- Close zippers, snaps and hooks to avoid snagging other items. Remove any sharp or heavy objects that could damage the dryer drum.
- Put small items (baby socks, handkerchiefs) in a small mesh bag for easier removal.
- Check garments to make sure all spots and stains were removed during the wash. If stains were not removed, do not tumble dry. Heat may permanently set the stain.

## Loading

### Load Sizes

- A proper size washer load is generally a proper size dryer load.
- For best drying results, do not dry more than two full-size sheets in one load, even if more than two sheets were in same washer load. Sheets need more space for proper air movement and maximum drying. Fill out the load with small items of the same type fabric.

### Fabric Softener

Dryer fabric softeners are recommended for reducing static cling and softening fabrics. Always follow package directions carefully.

**IMPORTANT:** Static cling can also be reduced by not overdrying the load or overloading the dryer.

- For best results, put a sheet of fabric softener on top of the load before starting the dryer.
- Do not add the fabric softener sheet after the cycle has started. Instant heat can cause the fabric softener to spot fabrics.

- If the fabric softener sheet becomes tangled or wrapped in one item during tumbling, a clear grease-like spot can result. If fabric softener has caused a stain, wet the stain and rub with liquid detergent or bar soap, then wash the item.
- Use only fabric softeners labeled as dryer safe. Some dryer fabric softeners can cause dryers with dryness sensors to overheat and/or fail to shut off. They can also clog the lint screen and slow drying. See "Lint Screen Maintenance" on page 11 for proper cleaning.

Static cling can be reduced by not overloading.

Service or performance problems caused by the use of any product not manufactured by KitchenAid are the responsibility of the manufacturer of that product.

# Make Selections

## **⚠ WARNING**

To reduce the risk of fire, electric shock or injury to persons, read the "Important Safety Instructions" on page 3 before operating your dryer.

### **Select a Cycle**

To set the desired cycle, turn the Cycle Control Selector either left or right. Stop turning when the marker points to the cycle and setting of your choice. Refer to the "Cycle Selection Chart" on page 12 for recommended cycles.

### **Start the Dryer**

To start the dryer, close the door, select a cycle and push START. The dryer will start tumbling when the START button is pushed.

To stop the dryer, open the door or turn the Cycle Control Selector to the OFF position.

### **To Stop and Restart the Dryer**

- Open the door or turn the Cycle Control Selector to OFF to stop the dryer.
- Close the door. Select a cycle (if necessary) and push the START button to restart the dryer.

The Cycle Control Selector should point to an OFF area when the dryer is not in use. If the dryer is stopped before the cycle is finished, turn the Cycle Control Selector to an OFF area.

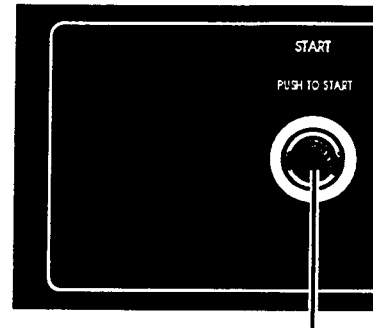

Start button

### **End of Cycle Signal**

Your dryer will sound a signal to let you know when the cycle you have selected is finished. The signal cannot be adjusted or turned off.

The signal is helpful when drying permanent press, synthetics, and other items that should be taken out as soon as the dryer stops tumbling.

### **Automatic Drying Cycles**

REGULAR/HEAVY and PERMANENT PRESS are both automatic cycles. The Cycle Control Selector can be set to indicate the degree of dryness you choose for the clothes being dried.

For the automatic drying cycles, a thermostat senses the dryer air temperature. The dryer automatically shuts off when the selected dryness is reached.

For the first few loads, set the Cycle Control Selector to the middle line between VERY DRY and LESS DRY in the cycle of your choice. If the result is drier than you like, set the selector closer to LESS DRY the next time you dry a similar load. If the result is not dry enough, set the selector closer to VERY DRY the next time you dry a similar load.

**Cushioned Heat™ Drying System:** In both automatic cycles, the dryer automatically reduces the heat setting to prevent overdrying of fabrics.



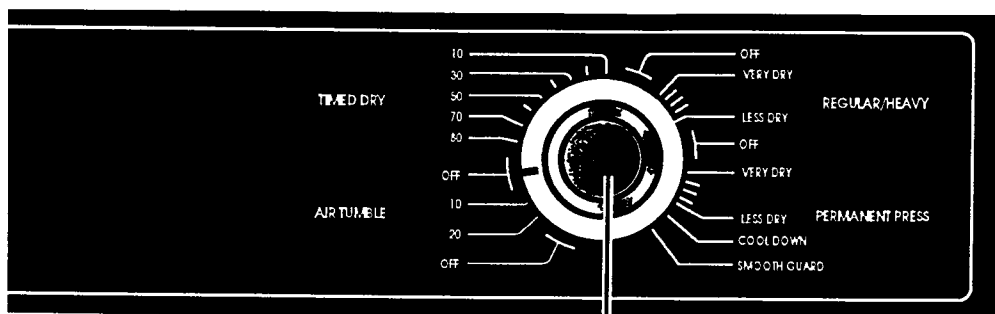

Cycle control selector

**Cool Down Time:** After the Cushioned Heat Drying time is finished, the dryer will tumble without heat during the last 5 minutes of the Automatic Regular/Heavy Cycle and the last 7 minutes of the Automatic Permanent Press Cycle. This helps keep wrinkles from setting, and makes the handling of hot load items easier.

The Cycle Control Selector will not move until the clothes load is almost dry, or until the COOL DOWN portion of the cycle has been reached. After COOL DOWN the selector will move to the OFF position and tumbling will stop.

### **Automatic Regular/Heavy Cycle**

This cycle can be used for heavy and mediumweight cotton items, such as towels, blue jeans, corduroys, bedspreads and linens.

### **Automatic Permanent Press Cycle**

Use this cycle to dry permanent press items, knits and other synthetic fabrics.

If you are unable to unload the dryer within 5 minutes after it stops tumbling, the **Smooth Guard™** Feature takes over automatically to protect your clothing from wrinkles. SMOOTH GUARD tumbles the load without heat every 5 minutes, continuing up to 40 minutes or until the door is opened to remove the clothes. SMOOTH GUARD is only featured in the Automatic Permanent Press Cycle.

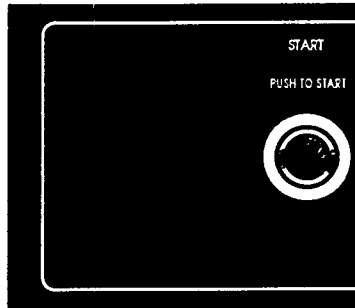

## *Air Tumble Cycle*

The dryer does not use heat when the Cycle Control Selector is set on AIR TUMBLE. Use this cycle to fluff bedding and pillows, to dust draperies and clothing, and to dry heat-sensitive items such as plastics, foam or sponge rubber, sneakers or stuffed toys.

Turn the Cycle Control Selector to the amount of time you want the load to tumble dry—up to 20 minutes. For some items, you may have to reset the dryer for additional time. Refer to the “Cycle Selection Chart” on page 12 for recommended drying times.

### **⚠ WARNING**

#### **Fire Hazard**

**Do not dry plastic or rubber items with heat. Use AIR TUMBLE Cycle, or line dry.**

**Failure to do so could result in fire or damaged items.**

## *Timed Dry Cycle*

Use the Timed Dry Cycle for any load you want to dry by time. Turn the Cycle Control Selector to the amount of time you want the load to tumble dry—from 10 to 80 minutes.

**Cushioned Heat™ Drying System:** The dryer automatically reduces the heat setting to prevent overdrying of fabrics.

**Cool Down Time:** The load tumbles without heat during the last 5 minutes of this cycle. This helps keep wrinkles from setting in and makes the handling of hot load items easier.

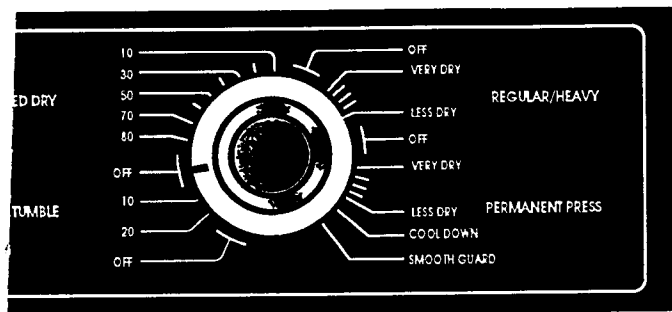

## Lint Screen

### **⚠ WARNING**

#### **Fire Hazard**

**Do not run your dryer with the lint screen loose, damaged, blocked or missing. Doing so can cause overheating, damage to fabrics and be a FIRE HAZARD.**

Clean the lint screen before each load. A screen blocked by lint can increase drying time due to poor air flow, and can be a fire hazard.

#### **To clean the lint screen:**

1. Open the lid and pull the lint screen straight out.

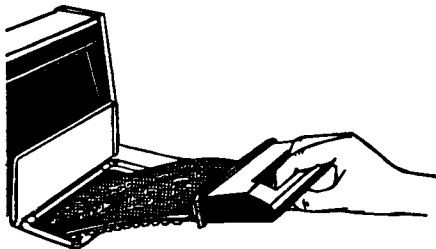

2. Roll the lint off the screen with your fingers.

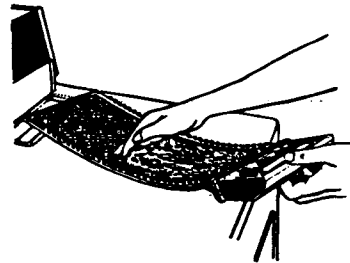

3. Do not rinse or wash the lint screen to remove lint. Wet lint can clog the screen mesh.
4. Push the screen firmly back into place.

### **Lint Screen Maintenance**

Laundry detergents and fabric softeners can cause a residue build-up on the lint screen. A clogged lint screen can extend drying times. Clean the lint screen every six months or more frequently if it becomes clogged due to a residue build-up. Use the following method:

1. Wet both sides of the lint screen with hot water.
2. Wet a nylon brush with hot water and liquid detergent.
3. Scrub lint screen with the brush until all residue build-up is removed.
4. Rinse with hot water.
5. **Thoroughly** dry lint screen with a clean towel and replace in dryer.

# Cycle Selection Chart

Type of Load	Suggested Cycle
<b>Cottons-Linens</b>	
EXTRA HEAVY-Bedspreads, mattress pads, quilts	AUTOMATIC REGULAR/HEAVY
HEAVYWEIGHT-Towels, jeans, corduroys, work clothes	AUTOMATIC REGULAR/HEAVY
MEDIUMWEIGHT-Sheets, pillowcases, cotton underwear, diapers	AUTOMATIC REGULAR/HEAVY
LIGHTWEIGHT-Batistes, organdies, lingerie	AUTOMATIC PERMANENT PRESS
<b>Permanent Press, Synthetics and Blends</b>	
HEAVYWEIGHT-Work clothes, jackets, raincoats	AUTOMATIC PERMANENT PRESS
MEDIUMWEIGHT-Shirts, play clothes, sheets, slacks	AUTOMATIC PERMANENT PRESS
LIGHTWEIGHT-Lingerie, blouses, dresses	AUTOMATIC PERMANENT PRESS
<b>Knits</b>	
HEAVYWEIGHT-Cottons, rayons, blends, T-shirts, slacks, shirts	AUTOMATIC PERMANENT PRESS
MEDIUMWEIGHT-Synthetics (polyester, acrylic), dress slacks, skirts, sweaters	AUTOMATIC PERMANENT PRESS
LIGHTWEIGHT-Synthetics (polyester acrylic) and blends, lingerie, blouses, dresses	AUTOMATIC PERMANENT PRESS
<b>Delicate Fabrics</b>	
Sheer curtains (2 or 3 panels), gauze, lace	AUTOMATIC PERMANENT PRESS

## WARNING

### Fire Hazard

Drying rubber, plastic and other heat-sensitive materials with heat can damage them or be a FIRE HAZARD.

### Rubber, Plastic, Heat-Sensitive Fabrics

FOAM RUBBER-Pillows, bras, stuffed toys	AIR TUMBLE 20-30 minutes
PLASTIC-Shower curtains, tablecloths	20-30 minutes
RUBBER-BACKED RUGS	40-50 minutes
OLEFIN, POLYPROPYLENE, SHEER NYLON	15-20 minutes

Drying times may vary according to load sizes and types. See page 16 for additional information.

# Caring for the Clothes Dryer

For maximum use satisfaction and longer dryer life, follow these guidelines:

- Do not place sharp or heavy objects on or in the dryer. Damage to the finishes may result.
- To clean dryer exterior, wipe with a soft, damp cloth.
- Never leave wet or damp laundry in your dryer. Damage to clothing or the dryer drum may result.

## Lint Removal

Lint can gather inside the dryer and be a fuel for fire. It is recommended the lint be removed every 2 to 3 years, or more often, depending on dryer usage. Cleaning should be done by a qualified person. If you have any questions, please call our Consumer Assistance Center at 1-800-422-1230.

## **⚠ WARNING**

### **Electrical Shock and Personal Injury Hazard**

- Unplug the power supply cord or turn off the electrical power before removing dryer panels.
  - Make sure the dryer is cool.
  - Dryer parts can have sharp edges. Use care when handling.
  - When replacing front panel after lint removal, the wire clips holding the door switch wires must be anchored to top of front and side panels. Wires **MUST NOT** touch rotating drum. (See page 14, step 7.)
- Failure to do so could result in electrical shock or personal injury.

### **If your dryer is electric:**

1. Unplug the power supply cord or turn off the electrical power.
2. Remove back panel.
3. Remove lint from shaded area (see illustration) with a soft brush or vacuum cleaner. Avoid damaging wires and thermostats.
4. Replace panel. Reconnect and level the dryer.

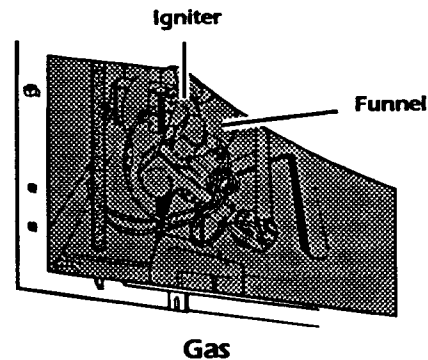
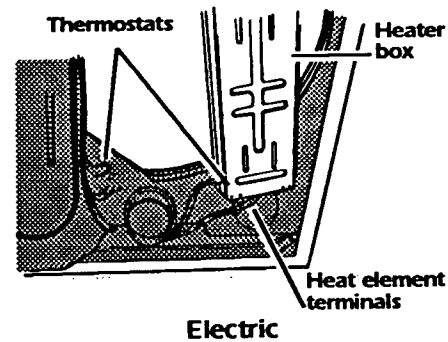

**If your dryer is gas, see page 14.**

If your dryer is gas and has a full front panel, remove front panel as follows:

1. Unplug the power supply cord or turn off the electrical power.
2. Open lint screen lid. Remove two screws from lint screen area.
3. Open top by pulling forward and up at each front corner (see view A). Rest raised top against wall behind dryer (top is hinged at rear).
4. Remove two internal screws from front panel flanges (near top front corners). Lift front panel slightly, lifting off lower clips (see view B). Slowly pull front panel forward, disengaging panel from drum. (Drum will drop slightly.)
5. Move front panel aside and rest edge against side of dryer. Avoid disconnecting wire clips (see view C) or damaging wires.
6. Remove lint from area shown in "gas dryer" illustration on page 13 with soft brush or vacuum cleaner. Avoid damaging wires, funnel or igniter.
7. Reassemble in reverse order. Before closing the top, check the following:
  - Drum seal must be flared out (see view D) and properly positioned against panel at back of drum.
  - Rotate drum counterclockwise one full turn to check drum seal.
  - Belt should be centered and tight on dryer drum.
  - Wire clips which hold the door switch wires must be anchored in slot in top of front panel (see view C) and along top edge of side panel. Door wires must not touch drum when dryer is operating.

**See Warning, page 13.**
8. Replace top panel and lint screen screws. Top and front panels must be securely in place before operating dryer.
9. Reconnect power and level dryer again (if necessary).

**NOTE:** Call Consumer Assistance at 1-800-422-1230 for assistance or more information.

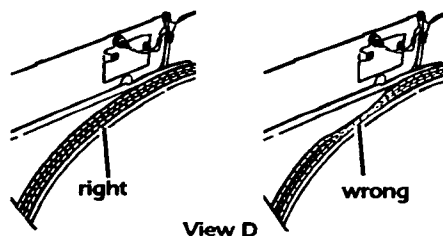
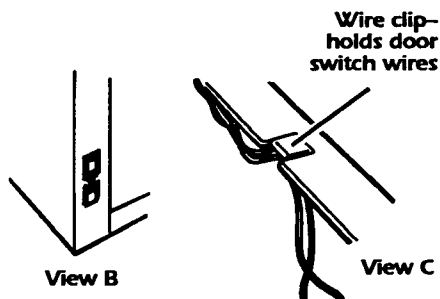
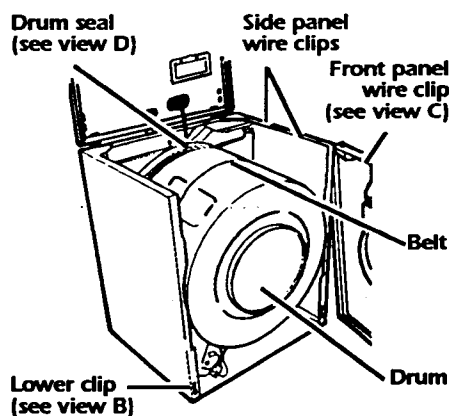
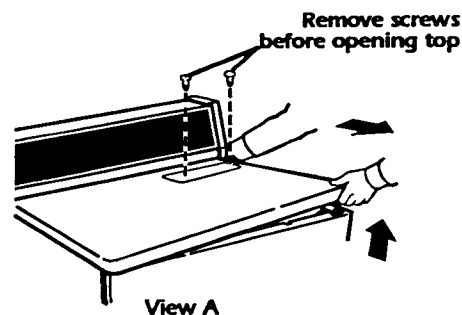

## Cleaning the Dryer

### **! WARNING**

#### **Electrical Shock and Personal Injury Hazard**

- **Unplug the power supply cord or turn off the electrical power before cleaning the interior.**
  - **Make sure the dryer is cool.**
- Failure to do so could result in electrical shock or injury.**

#### **Fire Hazard**

- **Use non-flammable cleaner.**
- Failure to do so could result in an explosion.**

Garments which contain unstable dyes, such as denim blue jeans or brightly colored cotton items, may discolor the dryer interior. If you want to remove stains from the dryer drum, use one of the following methods:

1. Use powdered laundry detergent and very warm water. Make a paste with detergent and water. Apply paste to a soft cloth and scrub area until all excess dye is removed. Wipe thoroughly with a damp cloth. Tumble a load of rags to eliminate any remaining detergent;
- OR
2. Use non-flammable liquid household cleaner. Apply to stained area and rub with a soft cloth until all excess dye is removed. Wipe thoroughly with a damp cloth. Tumble a load of rags to eliminate remaining cleaner.

To clean dryer exterior, wipe with a soft, damp cloth.

## Vacation Care

- Unplug power cord or turn off electrical power at the circuit breaker or fuse box.
- For gas dryers, close gas valve.
- Clean lint screen.

# Common Drying Problems and Causes

Problem	Cause
<b>Greasy-Looking Spots</b>	<ul style="list-style-type: none"> <li>• dryer fabric softener (See page 7 for correct use.)</li> <li>• undiluted washer fabric softener</li> <li>• drying soiled items</li> </ul>
<b>Lint</b>	<ul style="list-style-type: none"> <li>• load not sorted correctly</li> <li>• overloading</li> <li>• overdrying</li> <li>• full lint screen</li> <li>• mistaken "pilling" for lint The rubbing that fabrics receive during normal wear and washing raises a surface fuzz called "pilling." Pills do not break away easily from the fabric, and often collect lint. Use a lint roller, brush or cellophane tape to remove lint from pillled area. Synthetics and blends tend to pill more than other fabrics. Turn them inside out during laundering to prevent pilling.</li> <li>• paper or tissue in pockets</li> </ul>
<b>Shrinking</b>	<ul style="list-style-type: none"> <li>• overdrying</li> <li>• fabric type</li> </ul>
<b>Slow Drying</b>	<ul style="list-style-type: none"> <li>• load not sorted correctly</li> <li>• load type may require longer drying times</li> <li>• air movement slowed</li> <li>• lint screen is clogged</li> <li>• exhaust duct or outside exhaust hood clogged</li> <li>• dryer located in cold area</li> <li>• if wash load ended with a cool rinse, drying time will be slightly longer</li> <li>• large items rolled or balled</li> <li>• load too large</li> <li>• low voltage</li> <li>• vent too long (See Installation Instructions.)</li> </ul>
<b>Static Electricity</b>	<ul style="list-style-type: none"> <li>• overdrying</li> <li>• fabric type (Some synthetics will normally produce static electricity. Use dryer fabric softener. See page 7.)</li> </ul>
<b>Stiff, Harsh Fabrics</b>	<ul style="list-style-type: none"> <li>• wash load was off-balance, fabrics were very wet</li> <li>• line drying (use dryer to prevent stiff fabrics)</li> </ul>
<b>Wrinkling</b>	<ul style="list-style-type: none"> <li>• using incorrect cycle selection (See chart on page 12.)</li> <li>• overdrying</li> <li>• not removing clothes immediately after dryer stops tumbling</li> <li>• poor quality permanent press finish on fabrics</li> </ul>



# Drying Tips

1. Keep lint screen, exhaust duct and exhaust hood clean. If air movement is slowed down, drying times will be longer.
  - A clogged lint screen will increase drying time. **CLEAN LINT SCREEN BEFORE EACH LOAD.** If this is your first automatic dryer, you may notice a lot of lint on the lint screen. After the first few weeks of use, this surface lint from your clothes will be gone and lint on the screen will decrease.
  - A clogged, incorrectly installed or long length of exhaust duct will increase drying time. Exhaust duct should be as short and as straight as possible. See Installation Instructions.
2. Dryers should not be operated in rooms below 45°F (7°C). Drying times will be longer and wrinkles may not be removed if dryer is located in a cold room, such as a garage, unheated basement or porch.
3. Loads rinsed in cold water will take slightly longer to dry than loads rinsed in warm water.
4. Large loads take longer to dry than smaller loads of the same fabric. Check to see that large items, such as sheets, are not rolling or balling up. If balling or rolling up occurs, rearrange items.
5. Drying times should be longer for loads that hold more moisture. Large or heavy items such as towels, jeans and bedspreads need longer drying times due to the higher level of water retained in the fabrics. Polyester and synthetics hold much less moisture.
6. Loading practices will affect drying times.
  - Do not overload the dryer. For minimal wrinkling, clothes must be able to move freely in the dryer.
  - Overloading can cause slower, uneven drying. Poor air movement can result in more lint residue on clothing, because lint cannot reach the lint screen.
  - Uneven drying may also result from loading heavy and light items together. Light items will overdry and heavy items will not be dry. When drying a load with different kinds and weights of fabrics, use the setting suggested for the lightest fabric.
  - Small loads may ride around the drum without tumbling. Add one or two dry lint-free towels to help with tumbling.
7. This dryer is designed for the care of modern fabrics.
  - This dryer has a cool down time at the end of drying cycles. (See "Cushioned Heat™ Drying System" and "Cool Down Time" sections on pages 8 and 9.) This helps reduce wrinkling, but the total cycle may be longer than you are used to.
8. Avoid overdrying. Every fabric has a natural moisture content. If clothes are overdried, this moisture is removed. Clothes may have wrinkles, static electricity, feel harsh and, in some cases, shrink. Remove clothes with a slight trace of dampness. Damp cotton and rayon knits should be laid flat to finish drying.
9. Remove clothes from the dryer as soon as tumbling stops. Hang or fold immediately. Wrinkles may be set in clothes that are left in a warm dryer after it stops.

10. Even items labeled "Permanent Press" may require touch-up ironing, due to decreased quality of permanent press finishes during the past few years.

11. If the electric supply in your home is less than what is needed by your electric dryer, drying will take longer. See your Installation Instructions.

## Drying Special Items

Most garments and household textiles have care labels with laundering instructions. Always follow label directions when they are available. General drying instructions for some special washables are included in this section.

**IMPORTANT:** Dry only clean items. Soiled items can leave stains on the dryer drum. These stains can be picked up by other items in the load. Dryer heat may permanently set some stains.

### Blankets and Woolens

- Electric Blankets
- Woolen Blankets
- Washable Woolens

Follow these directions only if the manufacturer recommends machine drying.

1. Select TIMED DRY Cycle and set at 20 minutes.
2. To absorb moisture and dry the blanket rapidly, place three or four lint-free, dry towels in the dryer; turn dryer on and preheat for three to five minutes. This preheating helps absorb moisture and dry blankets rapidly to avoid pilling caused by long tumbling.
3. Place blanket in dryer with warm towels.
4. Check the blanket after 10 minutes of drying. Remove from the dryer while still damp to guard against overdrying which may cause shrinkage and harshness.
5. Place blanket on flat surface or over two lines to finish drying. Stretch blanket gently to original shape.

6. When blanket is completely dry, brush gently to raise nap. Press binding with cool iron if needed.

**IMPORTANT:** We do not recommend tumble drying knitted woolens. For best results, trace the outline of the garment on a clean piece of paper. After washing, block by finger pressing gently to this outline. Let the garment dry to this shape.

### • Cotton, Rayon, and Synthetic Blankets

1. Tumble dry using Permanent Press cycle. See "Cycle Selection Chart" on page 12.
2. Dry completely. Do not overdry.
3. Some cotton and rayon blankets stretch during washing. Drying completely restores to original size.
4. Remove from dryer as soon as it stops.

### Bonded or Laminated Items

Follow manufacturer's recommendations for machine drying.

1. Remove while slightly damp and air dry.
2. **Do not overdry.** Overdrying loosens the adhesive and causes fabrics to separate.

### Cotton and Canvas Play Shoes

1. Place several dry bath towels in dryer to act as a buffer.  
Use Air Tumble Cycle if rubber or foam rubber materials are part of shoe.
2. Remove when damp dry. Allow shoes to finish drying out of the dryer.

### **Curtains**

#### • Sheer panels

Curtains made from synthetic fibers such as nylon or polyester dry quickly, so they require only a few minutes of drying time.

1. Start with a cold dryer.
2. Dry only two or three panels at one time. Sheer curtains need plenty of room to fluff, so be careful not to crowd the dryer.
3. Remove from dryer while slightly damp. Do not overdry.

### **Diapers and Baby Clothes**

Check label for fiber content, then see "Cycle Selection Chart" on page 12 for cycle recommendation.

1. Remove diapers and cotton knit items from dryer while slightly damp so that they are easier to fold, feel softer, and shrink less.
2. For convenient handling, wash and dry small items in a mesh bag or pillow case.

### **Draperies**

Check label for fiber content, then see "Cycle Selection Chart" on page 12 for cycle recommendation.

1. Remove weights and hooks.
2. To help prevent wrinkling, dry only one or two drapery panels at one time, depending on size.
3. Remove from dryer as soon as it stops. (Some drapery fabrics may require little or no ironing if you remove them from the dryer while still slightly damp, then smooth and hang them.)

### **Flame Retardant Finishes**

Some items you buy may have been treated with a flame retardant finish to improve their resistance to burning if they are exposed to flame. Items treated in this manner will be clearly labeled.

To help reduce the possible loss of the flame retardant qualities through continuous use and washing, follow

laundry instructions furnished by the manufacturer of the item.

### **Glass Fiber Materials**

**Do not dry glass fiber materials in your dryer.** The fibers can break and remain in the dryer. These glass particles could become embedded in the fabric dried in the next load and cause skin irritation.

### **Heat Sensitive Fabrics**

- Olefin
- Polypropylene
- Plastics/Rubber
- Sheer Nylon

Use Air Tumble Cycle only.



### **Napped and Quilted Items**

- Chenille
- Fleecy Coats
- Mattress Pads
- Corduroy

Check label for fiber content, then see "Cycle Selection Chart" on page 12 for cycle recommendation.

1. Dry separately to avoid lint transfer.
2. Remove from dryer while there is still a trace of moisture. (Chenille spreads may be dried completely.)
3. Smooth, reshape, and air dry before putting away.
4. Choose shrink-resistant quilted items for best results.

### **Permanent Press Fabrics**

1. See page 12 for cycle which will give clothes the special treatment they need. Permanent press items need a period of heated drying to release wrinkles, followed by tumbling in room temperature air. This helps prevent new wrinkles from setting in.

2. Dry smaller loads. Items should tumble freely.
3. Remove clothes from dryer as soon as tumbling stops. Garments left in the dryer drum will become wrinkled.
4. Place garments on hangers or fold immediately after removal from dryer.
5. Well constructed permanent press items will be smooth and wrinkle-free when washed and dried correctly. Poorly finished or constructed permanent press may need "touch-up" ironing, especially where seams pucker.

#### Pillows

- Feather
- Down

Follow manufacturer's directions for drying.

1. Check ticking for holes or weak seams where feathers or filling could escape. Make necessary repairs before putting pillows in the dryer.
2. Stop drying occasionally and shake items to redistribute feathers.
3. Check pillows at end of drying time. If they are not completely dry, return them to the dryer and reset for more drying time. Remember that ticking will feel dry long before feathers are dry.

**IMPORTANT:** Feather pillows dry very slowly and must be dried completely to prevent mildewing. It may take 1½ to 2 hours. Dry no more than two pillows at one time.

#### Pillows and Stuffed Toys

- Polyester
- Foam Rubber
- Kapok

1. Be sure covers are securely stitched.
2. Use Air Tumble Cycle only.

### **⚠ WARNING**

#### Fire Hazard

**DO NOT dry foam rubber items on heat setting of dryer. Use Air Tumble Cycle or line dry. Drying in a heated dryer can damage the items or be a FIRE HAZARD.**

#### Plastic and Rubber Items

- Shower Curtains
  - Tablecloths
  - Baby Panties
1. Use Air Tumble Cycle only.

### **⚠ WARNING**

#### Fire Hazard

**Drying in a heated dryer can damage plastic or rubber items or be a FIRE HAZARD.**

2. Set the Cycle Control Selector to the Air Tumble Cycle for 20 minutes. Place 3 or 4 dry towels in the dryer with these items to help absorb the moisture.

#### Scatter Rugs

Check label for fiber content, then see "Cycle Selection Chart" on page 12 for cycle recommendation.

1. Dry one medium-size rug or two smaller rugs at one time. A rug should tumble freely. Do not overload.
2. Clean the lint screen.

### **⚠ WARNING**

#### Fire Hazard

**Use only Air Tumble Cycle for drying rubber-backed rugs. Drying rubber-backed rugs with heat can damage the rubber backing and be a FIRE HAZARD.**

### **Slipcovers**

Check label for fiber content, then see "Cycle Selection Chart" on page 12 for cycle recommendation.

1. Dry one slipcover at a time.
2. Remove from dryer while slightly damp.
3. Press pleating or ruffles, if you wish.
4. Put slipcover on furniture while a trace of moisture remains for a smooth, tight fit.

### **Snowsuits, Jackets**

- Nylon
- Polyester base

Check label for fiber content. See "Cycle Selection Chart" on page 12 for cycle recommendation.

1. Dry garment for about 10 minutes. Remove; turn inside out; replace for another 10 minutes. Remove and hang on a non-rusting hanger to finish drying.
2. Remove from dryer immediately after tumbling to help eliminate wrinkles.

### **Starched Items**

1. Dry starched clothes in a separate load.
2. Always start with a cold dryer. If drying more than one load, dry starched items first.
3. Turn dark articles inside out so starch spots will not show on the outside of the garment.
4. Check load about 5 minutes after drying starts to be sure items are tumbling freely and that nothing is sticking to the drum.
5. Do not overdry starched articles ... starch will shake off the garment and be lost.
6. For best results, remove clothes from dryer at ironing dampness. Place in a plastic bag and hold for at least 30 minutes to distribute moisture evenly before ironing.

7. After drying a heavily starched load, allow the dryer drum to cool, then wipe it out with a damp cloth. This guards against build-up or starch transfer to articles dried in later loads.

### **Tinted and Non-Colorfast Items**

Check label for fiber content, then see "Cycle Selection Chart" on page 12 for cycle recommendation.

1. After drying is completed, wipe the drum carefully to make sure there is no dye or lint that could be transferred to subsequent loads. If dye transfer does occur, follow the cleaning instructions on page 15.

### **Washable Knits**

Check label for fiber content, then see "Cycle Selection Chart" on page 12 for cycle recommendation.

1. Remove cotton and rayon knits (such as T-shirts, knit underwear) when still slightly damp. Stretch into shape and lay flat to finish drying.
2. Knits made of synthetic fibers (polyester, nylon, acrylic, etc.) and blends (polyester/cotton) tend to "pill." Rubbing during wearing and laundering causes small balls of fiber to form on the surface. Turn inside out to wash and dry. Remove from dryer as soon as tumbling stops.
3. Do not overdry. Overdrying can cause shrinkage and a build-up of static electricity. Some items may need touch-up ironing.

# For Service or Assistance

## Follow These Steps

1. If your dryer should fail to operate, review the following list before calling your dealer. You could save the cost of a service call.

### If your dryer does not run:

- Is the power supply cord plugged into a live circuit with the proper voltage?
- Is the door closed tightly?
- Have you checked your home's main fuses or circuit breaker box?
- Did you push the START button?

### If your dryer does not heat:

- The Air Tumble Cycle does not use heat, and the last few minutes of all cycles do not use heat.
- If your dryer is gas, is the gas turned on?
- An electric dryer uses 2 breakers or 2 fuses. If one breaker is tripped or one fuse is blown, the dryer may run, but not heat.

### If drying times seem too long:

- Is the lint screen clean?
- See the Slow Drying section in "Common Drying Problems and Causes" chart, page 16.
- Is exhaust duct or outside exhaust hood clogged?
- Is your electric dryer plugged into a 208-volt outlet? Drying times will be longer. If longer drying times are unsatisfactory, a higher wattage element is available. Contact KitchenAid Consumer Assistance Center or your local dealer.

2. If the problem is not due to one of the above items.\*
  - Call KitchenAid Consumer Assistance Center, TOLL-FREE:  
**1-800-422-1230**  
and talk with one of our trained consultants. The consultant can instruct you in how to obtain satisfactory operation from your

appliance or, if service is necessary, recommend a qualified service company in your area.

- If you prefer, write to:  
Consumer Assistance Center  
KitchenAid  
P.O. Box 558  
St. Joseph, MI 49085-0558  
Please include a daytime phone number in your correspondence.

### 3. If you need service:\*

- Call your dealer or the repair service he recommends.
- All service should be handled locally by the dealer from whom you purchased the unit or an authorized KitchenAid servicer.
- If you are unable to obtain the name of a local authorized KitchenAid servicer, call our service assistance telephone number. (See Step 2.)

### 4. If you are not satisfied with the action taken:\*

- Contact the Major Appliance Consumer Action Panel (MACAP). MACAP is a group of independent consumer experts that voices consumer views at the highest levels of the major appliance industry.
- Contact MACAP only when the dealer, authorized servicer and KitchenAid have failed to resolve your problem.

Major Appliance Consumer  
Action Panel  
20 North Wacker Drive  
Chicago, IL 60606

- MACAP will in turn inform us of your action.

\*When requesting assistance, please provide: Model Number, Serial Number, Date of Purchase and a complete description of the problem. This information is needed in order to better respond to your request.

# KitchenAid® Dryer Warranty

LENGTH OF WARRANTY:	KITCHENAID WILL PAY FOR:	KITCHENAID WILL NOT PAY FOR:
<b>ONE YEAR FULL WARRANTY</b> FROM DATE OF PURCHASE.	Replacement parts and repair labor costs to correct defects in materials or workmanship. Service must be provided by an authorized KitchenAid servicing outlet.	<p>A. Service calls to:</p> <ol style="list-style-type: none"> <li>1. Correct the installation of the dryer.</li> <li>2. Instruct you how to use the dryer.</li> <li>3. Replace house fuses or correct house wiring.</li> <li>4. Correct house plumbing.</li> </ol> <p>B. Repairs when dryer is used in other than normal home use.</p> <p>C. Damage resulting from accident, alteration, misuse, abuse, improper installation or installation not in accordance with local electrical or plumbing codes.</p> <p>D. Any labor costs during the limited warranty.</p> <p>E. Replacement parts or repair labor costs for units operated outside the United States.</p> <p>F. Pick up and delivery. This product is designed to be repaired in the home.</p> <p>G. Repairs to parts or systems caused by unauthorized modifications made to the appliance.</p>
<b>SECOND YEAR LIMITED WARRANTY</b> FROM DATE OF PURCHASE.	Replacement parts to correct defects in materials or workmanship.	
<b>SECOND THROUGH FIFTH YEAR LIMITED WARRANTY</b> FROM DATE OF PURCHASE.	<p>Replacement parts for any electrical element on electric models or any burner on gas models to correct defects in materials or workmanship.</p> <p>Replacement parts for the cabinet assembly should it rust through due to defects in materials or workmanship.</p> <p>Replacement parts for the "Gold Seal" motor to correct defects in materials or workmanship (all models except KEYL400W and KGYL400W).</p> <p>For solid state touch control models, replacement parts for the solid state controls if defective in materials or workmanship.</p>	
<b>SECOND THROUGH TENTH YEAR LIMITED WARRANTY</b> FROM DATE OF PURCHASE.	Replacement parts for the dryer drum if it rusts through due to defects in materials or workmanship.	

**KITCHENAID DOES NOT ASSUME ANY RESPONSIBILITY FOR INCIDENTAL OR CONSEQUENTIAL DAMAGES.** Some states do not allow the exclusion or limitation of incidental or consequential damages, so this exclusion or limitation may not apply to you.

This warranty gives you specific legal rights and you may also have other rights which vary from state to state.

If you need service, first see the "Service and Assistance" section of this book. After checking "Service and Assistance," additional help can be found by calling our service assistance telephone number, **1-800-422-1230**, from anywhere in the U.S.

® Registered Trademark/TM Trademark of KitchenAid